

Bumpers & Wheel Chocks

LAMINATED AND MOLDED MAXIMUM PROTECTION FOR LOADING DOCKS, TRUCKS & CARGO

Laminated Bumpers

- Absorb 80% or more of impact force.
- Pressure laminated between heavy structural steel angles.
- Sizes and thicknesses to fit all needs.
- Attaches easily to any surface.
- Models to meet government and postal requirements.
- Constructed of tread portion of belted ply tires only.
- Full length 3/4" steel rods welded to end angels - bolted end available.



Molded Bumpers

- Standard models in rectangular, "T" and "L Shapes.
- Nylon and rayon cord fibers throughout, minimizing chipping and tearing.
- Absorb shock of truck impact and spring to original shape.
- Some models available in 2", 3", and 4" thicknesses.
- Furnished with pre-drilled countersunk holes for easy installation and bolt head protection.

Laminated Wheel Chock

- Fabric-reinforced laminated rubber; resist weather and offer long service life.
- Recommended for compliance with OSHA requirements.
- Other applications include the chocking of aircraft, rolls, barrels, and trailers.
- Can be chained to dock for extra safety and efficiency.

Molded wheel chocks also available.

Model WC-8 measures 8"x10"x6" and weighs approximately 10 lbs.

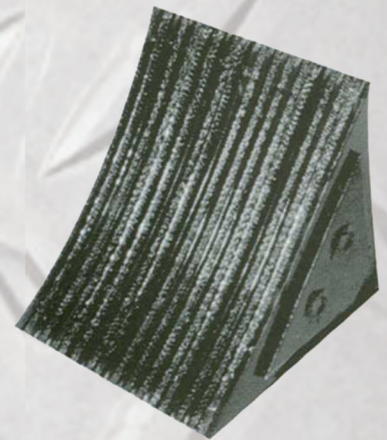

Quality Dock Levelers

Long Lasting

Easy to Install

Safe



Rugged. Dependable. PIONEER.

Bumpers & Wheel Chocks

Molded Dock Bumpers

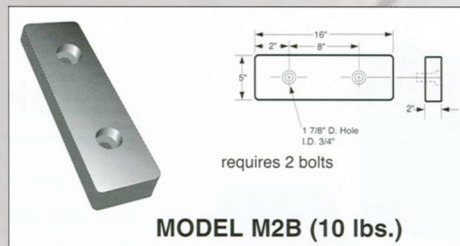
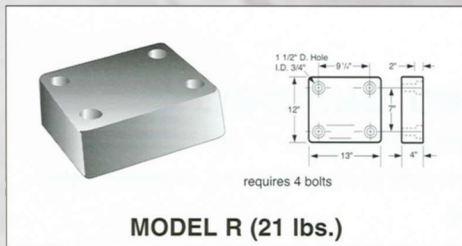
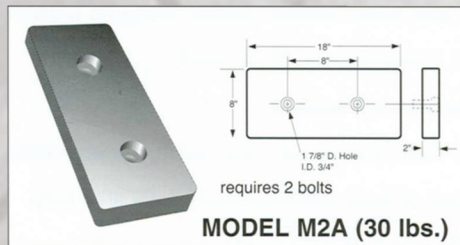
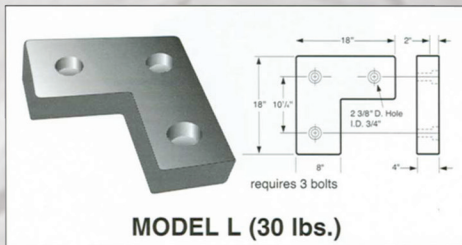
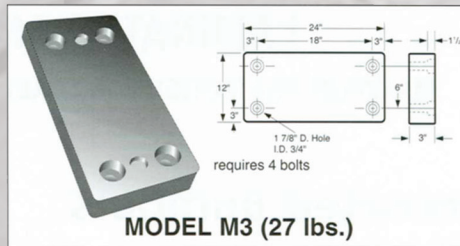
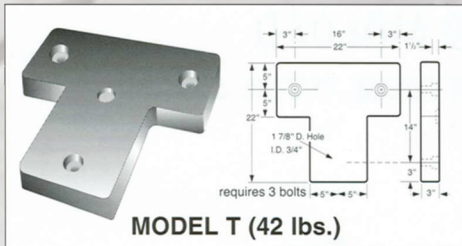

Specifications

Furnish and install molded, fiber reinforced rubber bumpers as furnished by PIONEER. Bumpers shall be reinforced with nylon and polyester fibers and shall meet or exceed ASTM 1170-95% AVE recovery rate standards.

Installation

Molded bumpers are furnished with pre-set countersunk anchor holes 3/4" in diameter. Anchors may be preset in new concrete or drilled into existing docks, Use 6" bolts for pre-set anchors and 5" bolts for drilled anchors. All bolts, hex nuts, and washers should be cadmium or galvanized plated.



Rugged. Dependable. PIONEER.

P.O. Box • Spring Hill, Tennessee 37174
Phone: 931.486.2296 • Fax: 931.486.0316
www.pioneerleveler.com

PIONEER offers a complete line of finely crafted, technologically advanced loading dock equipment, including **Hydraulic, Air Operated and Mechanical Pit Levelers, Edge-of-Dock and Hydraulic Top-of-Dock Levelers, Portable Dock boards, Vehicle Restraints, Dock Seals & Shelters, High Speed Fabric Roll-Up Doors,** and other quality accessories. Just call us toll free for personal, professional customer assistance and responses to all of your product needs.

toll free
1.800.251.3382

MODEL D Extruded Rubber Bumpers

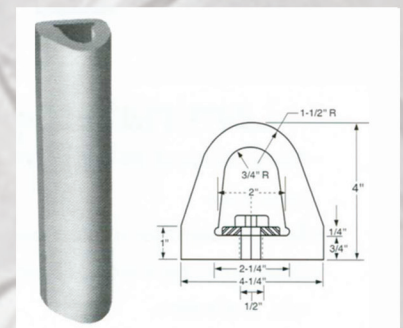

Extruded bumpers are appropriate for outdoor or indoor applications where impact protection is required. Lengths to 6'. Steel mounting bolts and washer furnished if desired. Holes are pre-drilled and units are ready to install.

Dealer Locations

PIONEER Dock Equipment is available nationwide. For the location of your nearest PIONEER Dealer call us toll free at **1.800.251.3382**.